



JAY-A55U



©2003 TIGER CORPORATION



TIGER CORPORATION
Head Office:3-1 Hayamicho, Kadoma City, Osaka 571-8571, Japan



炊きたて

Microcomputer Controlled Rice Cooker/Warmer

OPERATING INSTRUCTIONS
Before using your Rice Cooker, read these instructions through to the end.
After reading these instructions, keep them in a handy location for future reference by anyone who might use the Rice Cooker.

微電腦炊飯電子鍋

使用説明書
使用前務必仔細閱讀本使用說明書的全部內容。
閱讀後請務必保留在使用者容易看見的地方。

マイコン炊飯ジャー

取扱説明書
このたびは、ご購入いただきありがとうございます。ご使用になる前に、この取扱説明書
を最後までお読みください。
お読みになった後は、お買いになる方がいつでも見られるところに必ず保管してください。

마이콤 전기밥솥

취급 설명서
사용하기 전에 본 취급 설명서를 끝까지 읽어 주십시오.
읽으신 후에는 사용하실 분이 언제나 볼 수 있는 곳에 반드시 보관해 주십시오.

Contents

IMPORTANT SAFEGUARDS/SAVE THESE INSTRUCTIONS	2
CONVENIENT FUNCTIONS	3
1. SAFETY INSTRUCTIONS	4~9
2. NAMES AND FUNCTIONS OF COMPONENT PARTS	10·11
TIPS FOR COOKING	12
BEFORE COOKING RICE	14·15
3. HOW TO COOK RICE	16
WHEN RICE HAS BEEN COOKED	17
TIMER-CONTROLLED RICE COOKING	18·19
4. KEEPING RICE WARM	20
5. CLEANING AND MAINTENANCE	21~23
6. SETTING CURRENT TIME	24
7. IF YOU CANNOT COOK RICE PROPERLY	25
8. TROUBLESHOOTING	27
When the plug to the cooker is disconnected or the power supply is cut off	29
SPECIFICATIONS	30
STANDARD COOKING TIME	30

もくじ

便利な機能の紹介	31
1. 安全上のご注意	32~37
2. 各部のなまえとはたらき	38·39
ごはんをおいしく炊くためのコツ	40
ごはんを炊く前の準備	42·43
3. ごはんの炊きかた	44
ごはんが炊きあがったら	45
タイマー炊飯のしかた	46·47
4. 保温について	48
5. お手入れのしかた	49~51
6. 現在時刻の合わせかた	52
7. うまく炊けない?と思ったら	53
8. 故障かな?と思ったら	55
器具用プラグがはずれたときや停電があったとき	57
仕様	58
炊飯時間の目安	58

目録

各種便利機能簡介	3
1. 安全注意事項	4~9
2. 各部名稱及用途	10·11
美味可口的煮飯技巧	13
煮飯前的準備	14·15
3. 煮飯方法	16
米飯煮好後	17
用定時器的煮飯方法	18·19
4. 保溫	20
5. 保養方法	21~23
6. 現在時間的調對方法	24
7. 不能煮好飯時	26
8. 出現故障時	28
器具用插頭脫落及停電時	29
規格	30
煮飯所需時間	30

목 차

편리한 기능의 소개	31
1. 안전상의 주의	32~37
2. 각부의 이름과 활용	38·39
밥을 맛있게 짓기 위한 비결	41
밥을 짓기 전의 준비	42·43
3. 밥 짓는 법	44
밥이 다 되면	45
타이머로 밥짓는 법	46·47
4. 보온에 대하여	48
5. 손질 방법	49~51
6. 현재시간을 맞추는 법	52
7. 밥이 잘 안된다? 고 생각되면	54
8. 고장일까? 하고 생각이 되면	56
기구용플러그가 빠졌을 경우와 정전이 있을 경우	57
사양	58
밥짓는 시간의 표준	58

IMPORTANT SAFEGUARDS

When using electrical appliances, basic safety precautions should always be followed including the following:

1. Read all instructions.
2. Do not touch hot surfaces. Use handles or knobs.
3. To protect against electrical shock do not immerse cord, plugs, or (state specific part in question) in water or other liquid.
4. Close supervision is necessary when any appliance is used by or near children.
5. Unplug from outlet when not in use and before cleaning. Allow to cool before putting on or taking off parts.
6. Do not operate any appliance with a damaged cord or plug or after the appliance malfunctions or has been damaged in any manner. Return appliance to the nearest authorized service facility for examination, repair, or adjustment.
7. The use of accessory attachments not recommended by the appliance manufacturer may cause injuries.
8. Do not use outdoors. (this item may be omitted if the product is specifically intended for outdoor use).
9. Do not let cord hang over edge of table or counter, or touch hot surfaces.
10. Do not place on or near a hot gas or electric burner, or in a heated oven.
11. Extreme caution must be used when moving an appliance containing hot oil or other hot liquids.
12. Always attach plug to appliances first, then plug cord into the wall outlet. To disconnect, turn any control to "off", then remove plug from wall outlet.
13. Do not use appliance for other than intended use.

SAVE THESE INSTRUCTIONS

Servicing should be performed by an authorized service representative. This product is intended for household use.

A short power supply cord is provided to reduce the risk resulting from becoming entangled in or tripping over a longer cord. Longer detachable power supply cords or extension cords are available and may be used if care is exercised in their use. If longer detachable power supply cords or extension cords are to be used : (1) the marked electrical rating of the cords set or extension cord should be at least as great as the electrical rating of the appliance ; (2) if the appliance is of the ground type, the extension should be a grounding-type 3-wire cored ; and (3) a long cord should be arranged so that it will not drape over the counter top or table top where it can be pulled down by children or tripped over accidentally

The following instructions shall be applicable only for 120V:
This appliance has a polarized plug (one blade is wider than the other). To reduce the risk of electric shock, this plug is intended to fit into a polarized outlet only one way.

If the plug does not fit fully in the outlet, reverse the plug.

If it still does not fit, contact a qualified electrician.

Do not attempt to defeat this safety feature.

The appliance is not intended for use by young children or infirm persons without supervision. Young children should be supervised to ensure that they do not play with the appliance.

CONVENIENT FUNCTIONS 各種便利功能簡介

Timer-Controlled Cooking / 用定時器煮飯

You may preset the time to finish cooking.

"TIMER 1" and "TIMER 2" values.

預約煮好飯的時間。

記憶 2 個預約時間,「TIMER 1」和「TIMER 2」。

Seven Menu Selection / 7種「食譜」選擇

You can cook Porridge, Brown rice, and Mixed rice, in addition to normal rice (Plain rice and Quick cooking).

- **Plain rice**
Cooks polished rice normally.
- **Rinse-free rice**
Cooks rice that does not need washing.
- **Quick**
Cooks rice 10 to 15 minutes earlier than "Plain rice". (A little harder than cooking by using the "Plain rice" function)
- **Mixed rice**
Cooks delicious seasoned mixed rice.
- **Porridge**
Cooks rice porridge easily.
- **Brown rice**
Cooks healthy unpolished rice.
- **Germinated brown rice**
Cooks germinated brown rice that is rich in nutrition.

除供一般煮飯(白米·快炊)使用外,還可以炊煮「米粥」「糙米」「什錦飯」

- **白米 (Plain rice)**
一般煮白米飯時使用。
- **免洗米 (Rinse-free rice)**
可以炊煮無需淘洗也能煮飯的免洗米。
- **快煮 (Quick)**
可比「Plain rice」快10~15分鐘煮熟。煮成的米飯比「Plain rice」稍硬。
- **什錦飯 (Mixed rice)**
可炊煮可口的什錦飯。
- **粥 (Porridge)**
可以簡單地煮粥。
- **糙米 (Brown rice)**
可煮制健康食譜的糙米飯。
- **發芽糙米 (Germinated brown rice)**
可以炊煮營養價值高的發芽糙米。

SAFETY INSTRUCTIONS 1 安全注意事項

Be sure to read and observe the instructions shown below before using the product.

- Be sure to observe the safety instructions shown below in order to prevent you and other people from being injured.
- Do not peel off the caution label from the product.
- Keep this manual for your further reference.

使用前請務必仔細閱讀並遵守這些注意事項。

- 為了防止使用過程中給自身和他人帶來危險和造成傷害請務必遵守這些注意事項。
- 不要揭下貼在電飯鍋上的注意標籤。
- 閱讀後請保管在使用者顯而易見的地方。

This manual uses the following two types of symbols to indicate the degree of damage and/or harm caused by misuse of the product

注意事項用以下標記將因使用不當而造成的各種危險和傷害的程度劃分如下。



WARNING / 警告
Indicates the risk of death or serious injury if the instructions are ignored or the product is used improperly.
表示「可能會導致死亡或重傷」的事項內容。



CAUTION / 注意
Indicates the risk of slight injury or physical damage if the instructions are ignored or the product is used improperly.
表示「可能會出現人身傷害或物品損害」的事項內容。

Symbols / 圖示之例

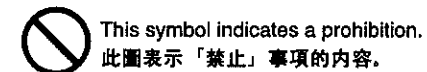

This symbol indicates a prohibition.
此圖表示「禁止」事項的內容。

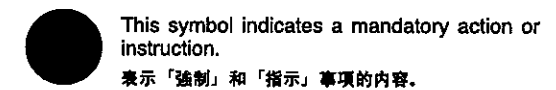

This symbol indicates a mandatory action or instruction.
表示「強制」和「指示」事項的內容。

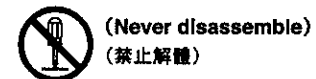

(Never disassemble)
(禁止解體)



(Mandatory action or instruction)
(強制、指示)

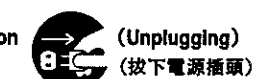

(Unplugging)
(拔下電源插頭)

! WARNING / 警告

Use the product at local Voltage only.

Using the product at any other voltage may result in fire or electric shock.



切勿使用額定電壓以外的電源。否則會引起火災、觸電。

Use an AC outlet of 7A or higher rating exclusively for the product with 220V or higher, and 15A or higher with 120V.

Connecting other instruments with the same AC outlet may cause the branch socket to overheat, resulting in fire.



交流220伏以上與交流120伏的額定電壓應分別單獨使用額定電流為7安培和15安培以上的電源插座。與其他電器共用時，分路插座處會因過熱而起火。

Do not damage the power cord. Do not use a damaged powercord.

Do not modify, bend, pull, twist or bundle the cord. Do not expose it to heat. Do not place something heavy on it. Do not clip it onto something. Noncompliance with these instructions may result in fire or electric shock.



請勿在電源軟線破損的情況下繼續使用。另外，請勿損傷電源軟線。加工、過度彎曲、靠近高溫部、擠拉、扭、捆、加載重物、夾住等。否則會引起火災、觸電等的危險。

Clean the plug if it is dirty.

A dirty plug may result in a fire.



應擦掉電源插頭上的灰塵，保持清潔。否則會引起火災。

Make sure the plug has been fully inserted into the power outlet.

Noncompliance with these instructions may result in electric shock, short-circuiting, smoke or fire.



務必將插頭插入電源插座底部。否則會導致觸電、短路、發煙和起火。

Do not use the cooker, if there is any damage to the power cord or the wall outlet, or if the plug cannot be fully inserted into the power outlet.

Noncompliance to this instruction may result in electric shock, short-circuiting or fire.



電源軟線及插入式插頭損傷或萬能插口的插入鬆動時，請勿使用。否則會導致觸電、短路和起火。

Do not connect or disconnect the plug with wet hands.

Handling the AC power cord with wet hands may result in electric shock or injury.



切勿用濕手插拔電源插頭。否則會發生觸電和導致受傷。

! WARNING / 警告

Prevent pieces of metal (pins, etc.) and dust from adhering to the head of the plug of the cooker.

Noncompliance with these instructions may result in electric shock, short-circuiting, and fire.



請勿讓器具用插頭的前端附著有鐵釘或金屬片及垃圾等物。否則可能會導致觸電、短路或着火。

Do not lick the plug.

Keep the plug away from infants and children, and do not let them lick the plug. It may cause electric shock or injury.



請勿舔器具用插頭。不要讓幼兒舔插頭。否則會導致觸電及受傷。

Never open the lid while cooking rice.

Opening the lid may result in burns.



煮飯中切勿打開鍋蓋。否則會導致燙傷。

Do not allow children alone to use the rice cooker. Keep it out of the reach of infants.

Noncompliance to this instruction may result in burns, electric shock or injury.



不要讓兒童單獨使用，應放置在幼兒够不到的地方。否則會有導致燙傷、觸電、受傷的危險。

Do not place your face and hands near the steam vent.

Touching the steam vent may result in burns. Keep out of the reach of children and infants.



請勿將臉及手靠近蒸氣孔。否則會導致燙傷。特別注意不要讓幼兒觸摸。

Do not immerse the rice cooker in water or splash it with water.

immersing or splashing may result in short-circuiting or electric shock.



禁止水浸、水洗。否則會導致短路和觸電。

Do not modify the rice cooker. Disassembly or repair should only be performed by qualified service representatives.

Noncompliance to this instruction may result in fire, electric shock or injury.



禁止改裝。除修理技術人員外，嚴禁任何人擅自拆卸和修理。否則會有引起火災、觸電和受傷的危險。

Do not put pins, wire, metallic objects or foreign matter into any gaps.

Inserting such objects may result in electric shock or injury due to malfunctioning.



禁止將針、鐵絲等金屬物品及其他異物夾在電飯鍋的空隙內。否則會引起觸電和故障而造成外傷。

CAUTION / 注意

Do not use the rice cooker in an unstable place or on a carpet easily affected by heat.

Doing so may result in a fire.



禁止在不穩定或耐熱性差的鋪墊上使用。
否則會引起火災。

Do not use the rice cooker near walls or furniture.

Steam or heat will cause damage, discoloration and/or deformation. Use the rice cooker 30 cm or more from walls or furniture. Be careful not to allow the shelf to become steamy when you use the rice cooker on a kitchen shelf.



禁止在靠近牆壁和家具的地方使用。
牆壁或家具受水蒸氣或熱量的影響會出現損壞、變色、變形等現象。使用時應與牆壁或家具保持30厘米以上的距離。
放在廚櫃內使用時，應保持良好的通氣。

Do not use the rice cooker near a heat source or where it may be splashed with water.

Heat or water may cause short-circuiting, leakage, deformation of the rice cooker, fire, or malfunction.



請勿在會淋到水或靠近煙火之處使用。
否則會引起觸電、漏電、火災和故障。
還會使主體部變形。

Use the inner pan exclusively made for this rice cooker. Using any other inner pans may result in overheating or malfunctioning.

Using any other inner pans may result in overheating or malfunctioning.



禁止使用專用內鍋以外的其他產品。
否則會出現過熱、故障。

Use the power cord specially designed for this cooker only. Do not use it with other appliances.

Noncompliance with these instructions may result in product failure or fire.



請勿使用本產品專用電源軟線之外的軟線。
請勿將電源軟線轉用於其它機器。
否則會導致故障或着火。

Do not touch hot parts while or immediately after cooking rice.

Touching hot parts may result burns.



使用過程中或剛剛使用後
不要觸摸高溫部位。
否則會導致燙傷。

Unplug the AC cord when the rice cooker is not in use.

Leaving the AC cord plugged may degrade insulation, resulting in injury, burns, electric shock, leakage, or fire.

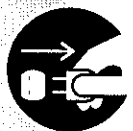

不使用時應從電源插座上拔下插頭。
否則有導致傷害和燙傷。
因絕緣退化引起觸電、漏電火災的危險。

CAUTION / 注意

Be sure to hold the plug when disconnecting the AC cable from the AC outlet.

Noncompliance to this instruction may result in electric shock or short-circuiting, resulting in a fire.



拔電源插頭時，務必要手持插頭部分，
禁止拉拽電源線。
否則會發生觸電或短路現象而起火。

Take care of the rice cooker after it has cooled down.

Touching hot parts may result in burns.



待電飯鍋冷卻後再刷洗。
觸摸高溫部位會引起燙傷。

Do not touch the hook button when carrying the rice cooker.

Otherwise, the lid may open, resulting in injury or burns.



移動電飯鍋時，禁止觸碰開蓋鉤鈕。
鍋蓋打開會導致受傷或燙傷。

NOTICE / 留意

Handle with care.

Dropping the rice cooker or applying strong shock may cause injury or malfunctioning of the rice cooker.

小心使用。

禁止摔落、撞擊，否則會導致傷害或出現故障。

Be careful not to be exposed to steam when opening the lid.

Exposure to steam may result in burns.

打開鍋蓋時，要注意蒸氣。
容易引起燙傷。

Do not connect several electrical appliances to a single AC outlet.

Doing so may result in fire.

不要使用分路插座。
容易引起火災。

Do not move the rice cooker while cooking rice.

Otherwise, you may scald yourself or hot water may boil over.

煮飯過程中不要移動電飯鍋。
容易引起燙傷或開鍋時水溢出鍋外。

Do not wash the entire rice cooker.

Do not wash the entire rice cooker or pour water into the cooker or its bottom. Such handling may result in short-circuiting or electric shock.

禁止水洗。

禁止用水沖洗主體，禁止主體內部和底部浸水。
否則會有引起短路、觸電的危險。

Be sure to observe the following instructions to use the rice cooker.

為了延長使用壽命請務必遵守以下事項。

Remove or wipe out the burnt rice, rice grains, or water drops, if any, on the outer surface of the inner pan, the heater, or the center sensor.

If rice is scorched or grains of rice are left on the pan, steam may leak or hot water may boil over, resulting in malfunctioning or failure to cook rice properly.

若有焦飯粒、米粒、水滴等黏在內鍋外側、熱板上、中心傳感器上時，請將其去除。

否則容易出現蒸汽外漏、開鍋時水溢出等故障。

Do not cover the rice cooker with a towel while cooking rice.

Otherwise, the rice cooker body or lid may be deformed or discolored.

煮飯過程中不要用擦碗布覆蓋鍋蓋。

否則容易使電飯鍋及鍋蓋變形、變色。

There is a hole on the cooker, and it is designed to maintain its functions and performance. In very rare cases, dust or insects may go through the hole. If you find a problem with the appearance or function, please contact the store where you purchased the product.

為了維持功能、性能，產品中設置有孔洞，因為偶爾會發生有灰塵及蟲隻進入這一孔洞。如果在外觀上或功能上有障礙時，請諮詢購買處的銷售店。

When the inner pan is deformed or corroded, please contact the store where you purchased the product.

內鍋出現變形及腐蝕時，請諮詢購買處的銷售店。

Strictly observe the following instructions to avoid blistering or removal of fluorocarbon resin on the surface of the inner pan.

- Do not put the inner pan over a gas fire or an electromagnetic cooker. Do not heat it in a microwave oven.
- Use the heat-retention function only for polished rice and rinse-free rice.
- Do not use vinegar on the inner pan.
- Use the supplied spatula or wooden spatulas only.
- Do not use hard utensils like metal ladles, spoons, or whisks.
- Do not place a basket on the inner pan.
- Do not place tableware and other hard utensils in the inner pan.
- Do not use hard materials, such as wire wool or plastic kitchen sponges, when washing the pan.

為避免引起內鍋氟樹脂加工面的膨脹及剝落，請務必遵守以下使用方法。

- 請勿放置在瓦斯爐上或放在電磁爐微波爐等中使用。
- 只保溫大米，免洗米。
- 請勿在內鍋中使用鹽。
- 只使用附帶品或木製勺子。
- 不可使用金屬製的刷帚、匙子或打泡器等硬物品。
- 不可在內鍋中使用灰塵。
- 不可在內鍋放入餐具等硬物品。
- 不可使用金屬製刷帚及尼龍刷帚等硬物刷洗內部。

Names and Functions of Component Parts

2

各部名稱及用途

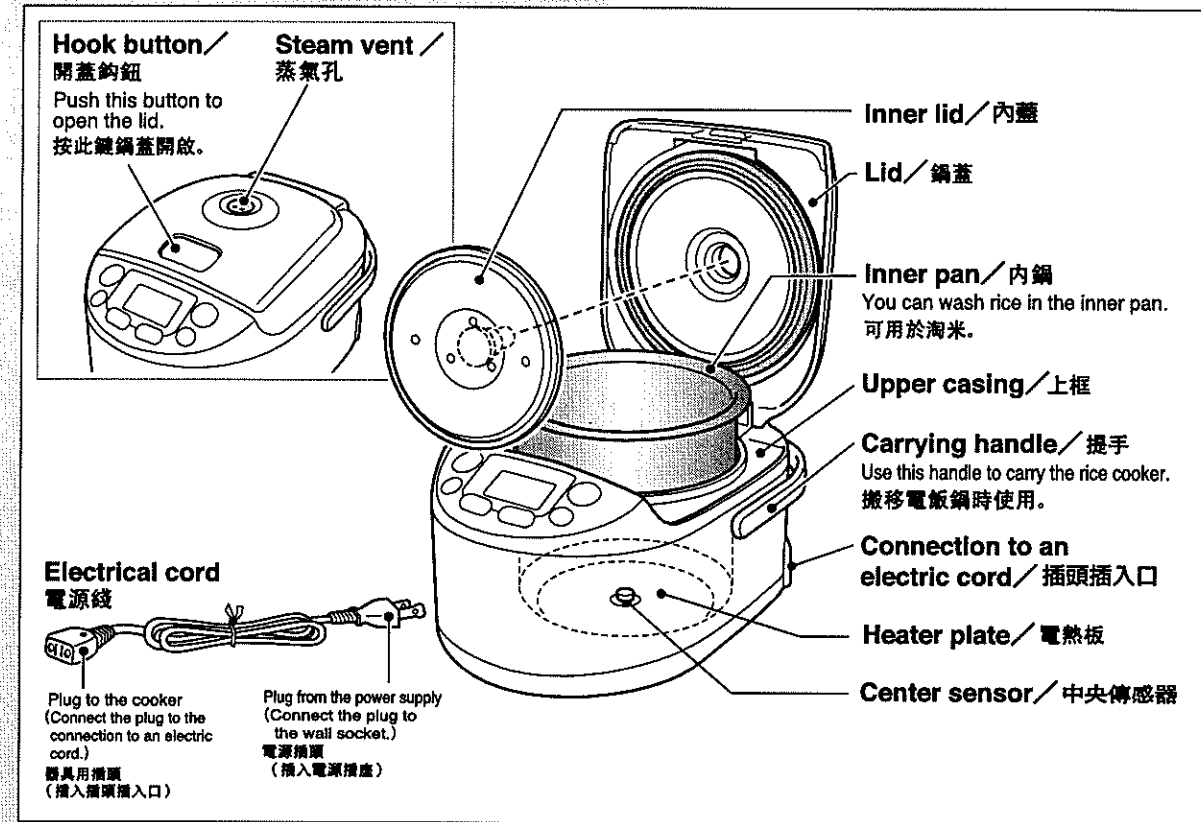

※The rice cooker has a built-in lithium battery and stores the current time and preset time even after the AC power cord is unplugged.

●The lithium battery has a four- to five-year life expectancy, provided that the power cord is unplugged.

●When the lithium battery runs out, [0:00] blinks on the display until when the power cord is plugged in. It is ready for normal operation. However, when the power cord is unplugged, the clock memory, the previously set timer and the display of elapsed time of warming rice will all be erased.

※Do not replace lithium batteries by yourself, which may cause damage or an accident.

※Contact the shop where you purchased the product when

※內裝有「鋰電池」，即使拔下插頭後也可繼續記憶現在的時間及預約時間。

●鋰電池在拔除電源軟線插頭的狀態下具有4-5年的壽命。

●如果在鋰電池消耗完之後，插入電源軟線插頭，「0:00」就會閃爍。雖然能夠進行通常的煮飯，但是拔掉電源軟線的插頭後，目前的時間及預約時間、保溫經過時間的記憶就會消失。

※為避免可能造成事故及故障的原因，請勿自行更換鋰電池。

※關於新鋰電池的更換，請諮詢購買處的銷售店。

Operation Panel

操作板部

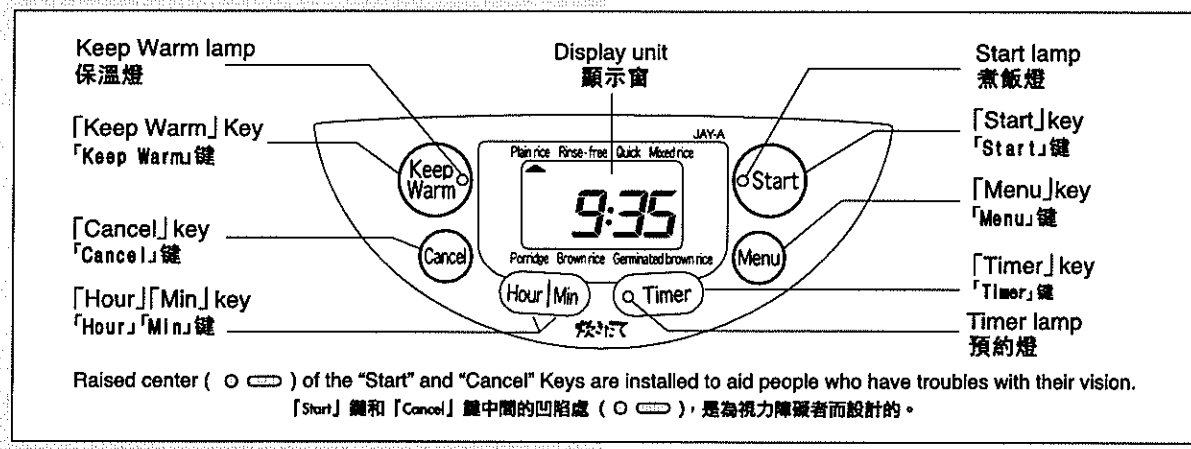

Checking Accessories

確認附件

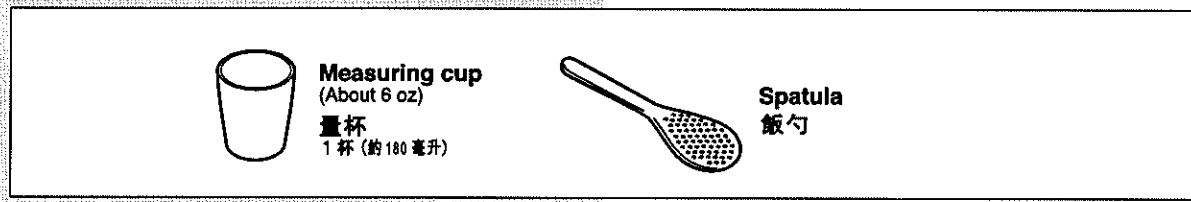

Checking Time

確認時間

The time is displayed in the 24-hour system. If the incorrect time appears on the display, please correct it to the current time. (See P.24)

Plain rice Rinse-free Quick Mixed rice

9:35

Porridge Brown rice Germinated brown rice

以 24 小時制顯示時間。如時間不準確時，請對好現在時間。(參照第 24 頁)

Other noise

The following noises issued from the rice cooker during cooking, steaming and warming of rice are not an indication of a problem:

- Clicking (caused by micro computer control)
- Snapping (The sound of metal contracting due to a change in the heating temperature)
- Splashing (while warming or steaming after cooking)

關於其它聲音

煮飯、燜鍋及保溫時會出現如下聲音，這不屬於異常情況。

- 「喀喀喀」的聲音 (微型計算機控制聲音)
- 「啪嗒啪嗒」的聲音 (金屬受熱後收縮磨擦的聲音)
- 水迸開的聲音 (僅限於保溫時、燜鍋時)

Tips for cooking

For preparation, refer to the page 14~15. For cooking procedures, refer to pages 16~19.

Choose rice of high quality and store it in a cool place.

Choose freshly polished, glossy rice of the same grain size. Store it in a cool, dark, well-ventilated place.

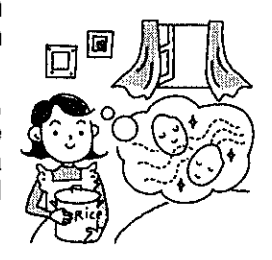

Adjust the volume of water according to the type of rice and your preferences.



Guideline for fine adjustment of water

Menu	Guideline for water (see the scales inside the inner pan)
Plain rice, Rinse-free rice, Quick, Germinated brown rice, and Mixed rice	Use the scale for [Plain rice] and adjust according to your preference.
Porridge	Use the scale for [Soft porridge] or [Hard porridge] for soft and hard porridge. Adjust to the middle of the two scales for mid-type porridge.
Brown rice	Use the scale for [Brown rice.]

- ※ When you adjust the volume of water, avoid adding or subtracting more than one third of one scale.
- ※ When you cook rice with embryo buds or barley-and-rice, please add slightly more water than you would for plain rice.

Measure rice carefully with the supplied cup. (A cup equals approximately 6 oz.)

Use the supplied cup for Rinse-free rice as well. You do not need a special cup for this type of rice as the cooker will accommodate rinse-free rice.

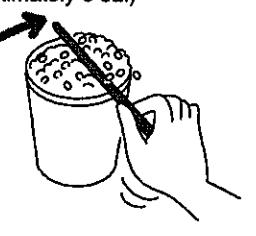

Quickly rinse the rice

with a generous quantity of water and pour off the water. Repeat the process until the water becomes clear.

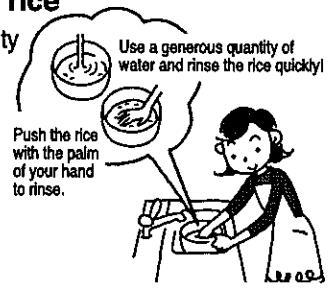

When you add vegetables or meat, add 70 grams of vegetables or meat at maximum to a cup of rice.

Fully stir the water with seasoning in it and place the vegetables or meat on the rice.



Please ensure that you comply with the maximum amount of rice indicated (the table below) when you cook rice together with other ingredients in this rice cooker.

Mixed rice	Up to 2 cups
100% rice porridge	Up to 0.5 cups
Brown rice	Up to 1.5 cups

Select the [Plain rice] setting using the Menu key, when you wish to cook lightly polished rice, rice with embryo buds, and barley and rice.

Please select the "Porridge" setting via "Menu," when cooking "porridge."

When you cook Rinse-free rice,

stir the rice in water from the bottom of the pan so that the rice is fully soaked in water.

Starch tends to settle at the bottom, which causes burnt rice. If you still see starch, repeat the rinsing process once or twice.



When cooking a mixture of brown and plain rice

- If the mixture of rice you are going to cook contains more brown rice than plain rice, please select the "Brown rice" setting.
- In cases where the ratio of brown rice to plain rice you intend to cook is equal or less, please select the "Plain rice" setting. (Prior to cooking brown rice, please soak the brown rice for 1-2 hours in order for the rice to sufficiently soak up moisture.)

When you are going to cook germinated brown rice together with some plain rice

Please select the "Germinated brown rice" setting.

美味可口的煮飯技巧

選擇良好的大米，並保存在陰涼的場所
請選擇碾米日期短、顆粒均勻並有光澤的大米。請保存在通風良好、陰涼的場所。



使用附帶的計量杯正確地計量 (1杯為約0.18L)

※免洗米也請用附帶的計量杯計量。本產品對煮飯方法進行了精心的研究，因此不需要免洗米專用的計量杯。

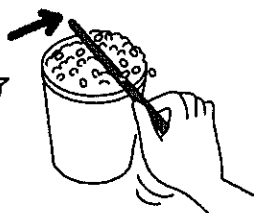

淘洗大米要快

用足夠的水快速攪拌，直到水變清。

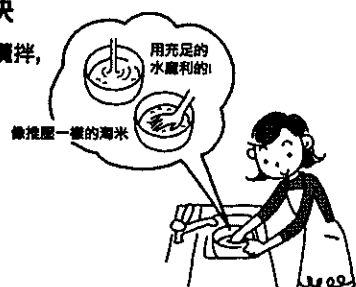

炊煮分級米、胚芽米、麥米飯時，請選擇「Plain rice」食譜。

※炊煮米粥時，請選擇「Porridge」

炊煮免洗米時

從底部開始充分地攪拌，以便能浸泡所有大米。

※由於澱粉容易積存在內鍋底部，因此有時會出現燒焦的情況。此時，請換水清洗1~2次。



煮飯前的準備請閱讀第14~15頁，
煮飯方法請閱讀第16~19頁。

根據大米的種類及自己的喜好加減水量。



●加減水量的標準表

菜單	加減水量的標準 (按照內鍋內側的刻度)
白米、免洗米、快煮、發芽糙米、什錦飯	以「Plain rice」的刻度為準，按自己的喜好加減水量。
粥	全粥時，為「Soft Porridge」的刻度。五分粥時，為「Hard Porridge」的刻度。七分粥時，在「Soft」和「Hard」刻度之間。
糙米	以「Brown rice」的刻度為準，按自己的喜好加減水量。

※從標準的刻度加減水量時，請避免進行1/3刻度以上的加減。
※胚芽米、麥米飯時，請將水加到略多於「Plain rice」的位置。

放入切碎的蔬菜、魚、肉等後煮飯時

對於1杯大米，切碎的蔬菜、魚、肉等在約70g以下。請攪拌好調料，並將切碎的蔬菜、魚、肉等放在大米上面。放入配料煮飯時，請務必遵守最大煮飯量 (下表)。



什錦飯	2合以內
全粥	0.5合以內
糙米	1.5合以內

在糙米中加入白米煮飯時

- 糙米比白米量多時，請選擇「Brown rice」。
- 糙米與白米的量相同、或糙米比白米量少時，請選擇「Plain rice」。(此時，請將糙米浸泡1~2小時吸收水份後再進行炊煮。)

在發芽糙米中加入白米時

請選擇「Germinated brown rice」。

Before Cooking Rice

Measure rice and put it into the inner pan.

Use the measuring cup supplied with the rice cooker.
(One level cup of rice is about 6 oz.)

Use the supplied cup for rinse-free rice as well. Observe the specified volume of rice (see the specifications on page 30) or the rice may not cook properly (A cup equals approximately 0.18 liters.) In particular, if you fail to observe the maximum volume, the rice may boil over or fail to cook properly.

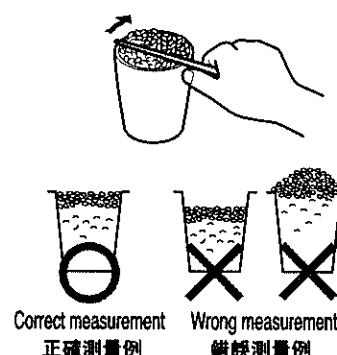

1 用量杯量好米，放入內鍋。

裝滿所附的量杯後刮平，一杯約一合(約180毫升)

免洗米也請用附帶的計量杯計量。如果不在指定的煮飯量 (參照P30的規格表) 內進行煮飯，有時煮飯效果就會不理想。(1杯=約1合) 特別是，請勿超過最大煮飯量。有可能會發生飯汁溢出及煮飯效果差的情況。

Wash rice by hand.

You can wash rice in the inner pan.
※Rinse-free rice does not need rinsing.
●Wash rice sufficiently.
●Do not use hot water (over 95°F (35°C)) to wash rice.

Wash rice in a short time until water becomes clear. Drain off water quickly.

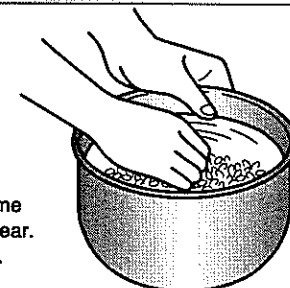

可用內鍋淘米。

- ※使用免洗米的情況時，無需淘洗大米。
- 一定要將米淘洗乾淨。
- 不要用(超過35°C)的熱水淘米。

迅速洗米直到水變清時為止
倒水要迅速

Place the inner pan on a level table and adjust the water level to the scale on the inner surface of the inner pan.

3 放平內鍋，根據內鍋內側的刻度加減水量。

When you cook two cups of polished rice, adjust the water level to the 「2」 on the 「Plain rice」 scale.

- Do not use hot water (95°F (35°C) degrees centigrade or higher).
- Check the type of rice and menu. Adjust the volume of water according to your preference. (See the guideline on page 12.)
- Use the 「Plain rice」 scale for 「Rinse-free rice」. (See pages 12.)

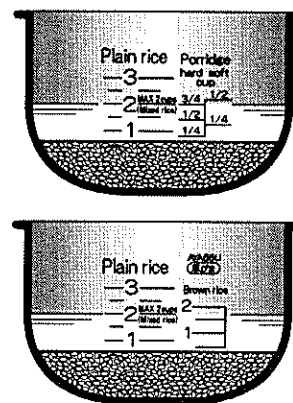

炊煮2杯的白米時對準白米的刻度2。

- 請勿用熱水 (35°C以上) 加減水量。
- 請確認大米的種類、菜單後，根據自己的喜好加減水量。(參照P13的標準表)
- 關於免洗米，可與白米使用相同的加減水量煮飯。(參照P13)

Wipe off water drops, rice grains, etc. from the outer surface and brim of the inner pan.

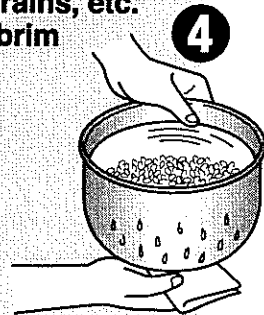

4 擦掉內鍋外側的水滴和米粒等。

Make sure that no rice grains, etc. are stuck on the inside of the rice cooker.

5 確認電飯鍋主體內側是否粘附有米粒等。

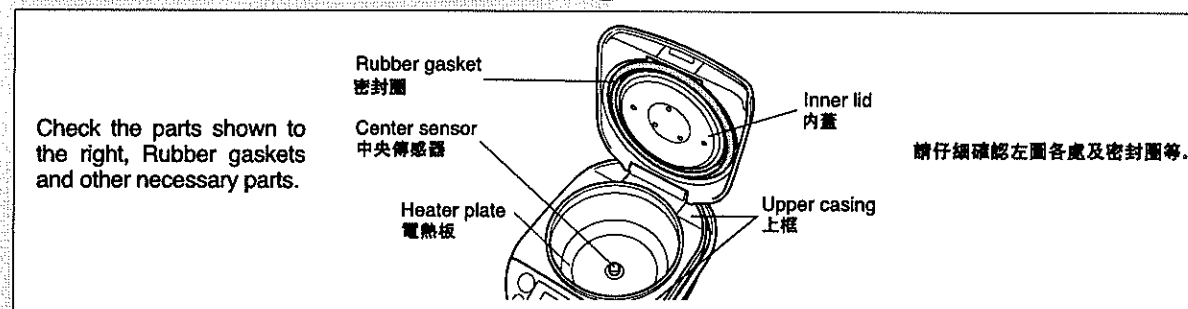

Set the inner pan in the rice cooker.

6 將內鍋放入電飯鍋主體內。

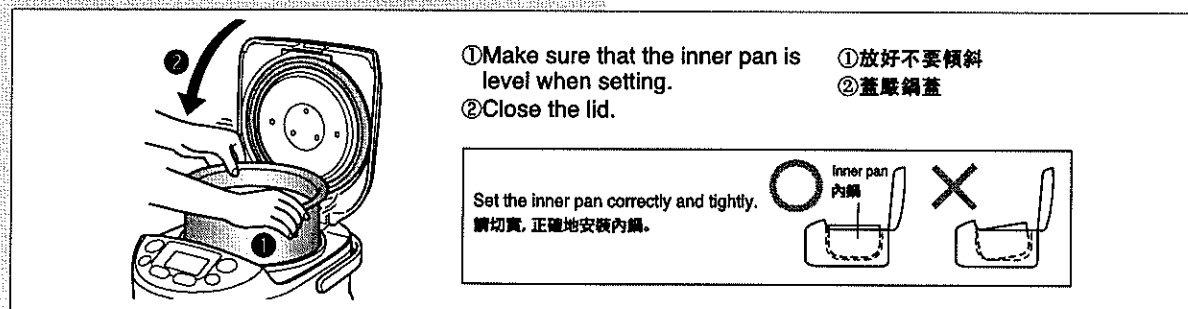

Insert one plug into the cooker and the other plug into the power outlet. Check that the Keep Warm lamp is off.

7 將器具用插頭插入主機、將插入式插頭插入萬能插口，確認保溫燈是否熄滅。

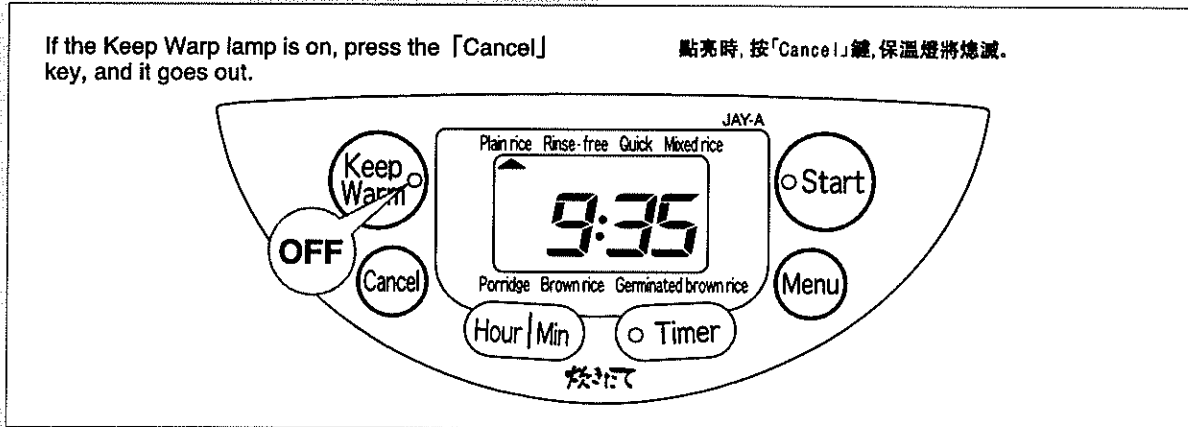

HOW TO COOK RICE

3

煮飯方法

Press the [Menu] key to select an intended menu.

1 按「Menu」鍵，選擇食譜。

Every press of the Menu key changes the menu in the order as shown below.

每按一次，食譜將依次變換。

※If the menu is preset, you do not need to select the menu here.

※事先選擇有菜單時，無需進行菜單選擇。

Please Note Due to the shorter cooking time, rice cooked using the "Quick" setting will be slightly al dente, when cooked, unlike that of rice cooked on the "Plain rice" setting.

請注意 與「白米」相比，「快煮」的煮飯時間較短，故所煮米飯也較硬。

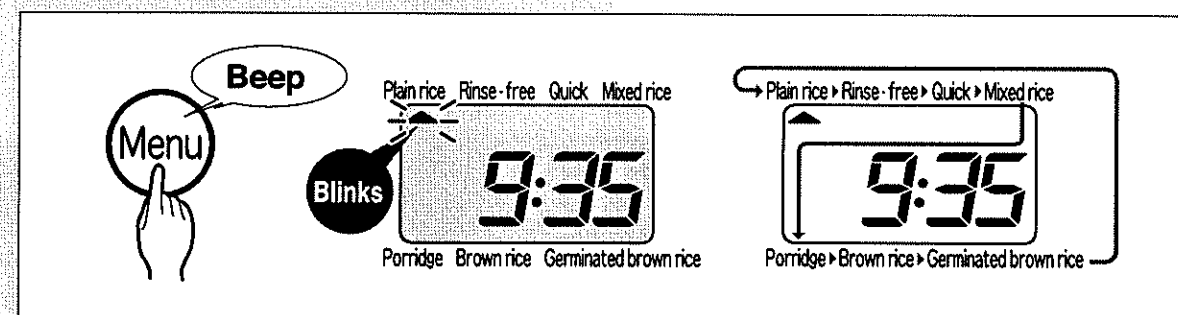

Press the [Start] key once.

2 按一次「Start」鍵。

The triangle indicator in the display unit stops blinking, and the rice cooker begins to cook rice. (For the cooking time, see page 30.)

顯示窗的▲停止閃爍，開始煮飯。(煮飯時間請參照第30頁)

※The remaining cooking time does not include steaming after cooking.

※煮好飯的剩餘時間不包括「燜煮」的時間。

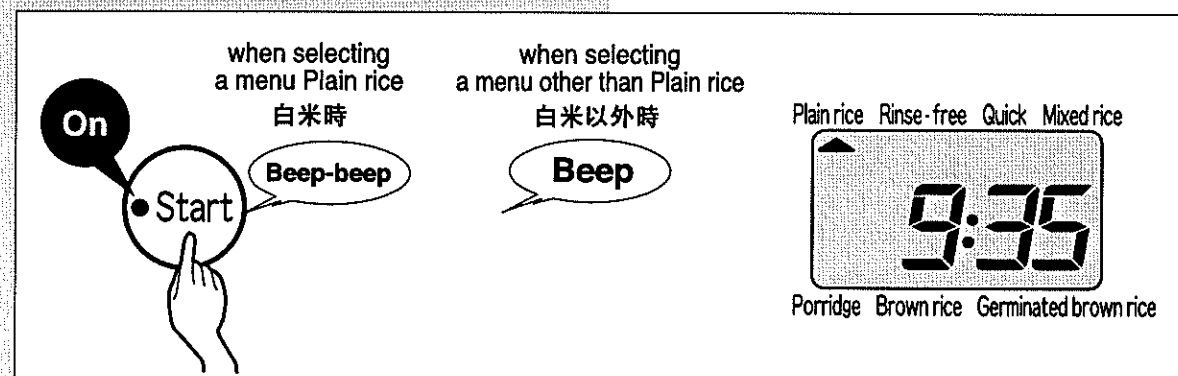

Do not put too many ingredients in when cooking mixed rice, or porridge with ingredients. Do not mix ingredients with rice. Otherwise, rice with ingredients may not be cooked properly. (Ingredients: 0.154 lbs (70g) or less per cup of rice)

炊煮什錦飯或摻有其他菜香的粥時，不要放入過多的菜肴。另外不要將菜肴與大米攪拌。這有時會影響炊煮效果。(一杯米不可放入超過70克的菜肴)

When Rice Has Been Cooked

When steaming cooked rice

The time remaining before completion of steaming is displayed in 1-minute intervals on the display unit.
 ※The steaming time differs with the menus.

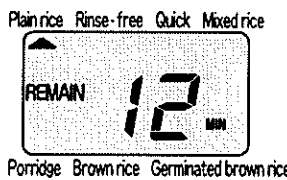

顯示窗上按 1 分鐘間隔顯示煮好飯所需的剩餘時間。
 ※根據食譜不同燜煮時間有所不同。

1 「燜煮」時

When cooking is completed

The cooker automatically switches to the keep-warm function when rice is cooked.
 ※Porridge should not be warmed long, as it will cook further and become like glue. We recommend that you eat it at your earliest convenience. (The Keep warm lamp blinks.)

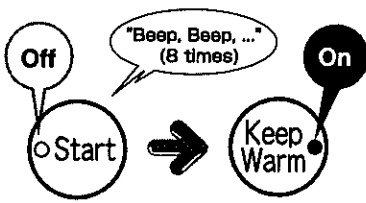

自動切換到保溫。
 ※關於「粥」，如果放置不釀，就會成爲糊狀或發黏，因此請儘快食用。(保溫燈閃爍)

2 煮熟後

Stir and loosen the cooked rice.

When cooking is complete, be sure to stir and loosen the rice immediately.
 If hot water drops into the groove or on outer surface of the cooker when you open the lid immediately after cooking or while warming, wipe it off.

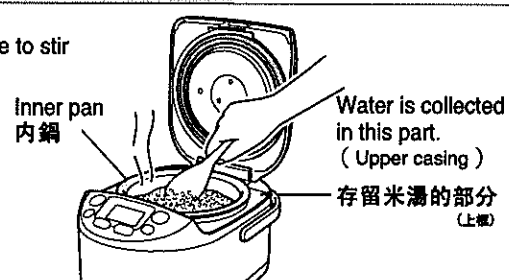

煮熟飯後應立即攪拌。
 剛煮好飯後及保溫過程中打開蓋子時，水滴會落到上框及外部，此時請擦拭。
 Water is collected in this part. (Upper casing)
 存留米湯的部分 (上框)

3 攪拌米飯

After Using Cooker/Warmer

1. Press the [Cancel] key. Pressing the [Cancel] key extinguishes the Keep warm lamp.
2. Disconnect the plug from the power supply and the other plug from the body.

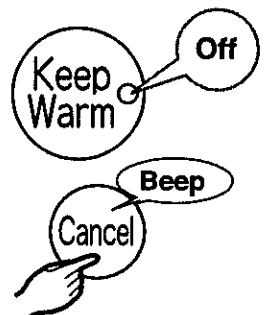

使用結束後

1. 按「Cancel」鍵。
按下「Cancel」鍵，保溫燈就會熄滅。
2. 拔下電源線，拔下器具用插頭。

Timer-Controlled Rice Cooking

- You may preset the time to finish cooking.
- The rice cooker stores the preset time even after unplugging the AC power cord.
- "TIMER 1" and "TIMER 2" values.

The timer-controlled cooking does not apply to the following cases:
 ●Time other than the below-shown time

Menu	The timer cannot be set if rice is to be cooked in:
Plain rice	Less than 65 minutes
Rinse-free rice	Less than 65 minutes
Porridge	Less than 70 minutes
Brown rice	Less than 90 minutes
Germinated brown rice	Less than 65 minutes

- Timer cannot be set up when you select the [Quick] or [Mixed rice] setting from [Menu].
- When the clock display shows "0:00" and is flashing.
- When the Keep Warm lamp is on, please press the [Cancel] key to turn off the lamp. (The timer cannot be set while the lamp is on.)

- ((Sound))
- When you press the [Timer] key and did not input anything, the alarm will sound 30 seconds later to notify you of the timer being set.
 - When you press either the [Timer] key or the [Start] key and the rice cooker is set to a condition in which the timer cannot be set, the alarm will sound immediately to notify you of your selecting an invalid operating option.

Check the current time.

※See page 24 for setting the current time.

1

確認現在的時間。
 ※針對現在時間的方法請參照第24頁。

Make sure that the Keep Warm lamp is off. Press the [Timer] key.

2

確認保溫燈熄滅後，按「Timer」鍵。

"TIMER" blinks on the display unit, and the current time changes to the preset time (or previously preset time).
 ※Every press of the [TIMER] key alternates blinking "TIMER 1" and "TIMER 2." Select either preset time.

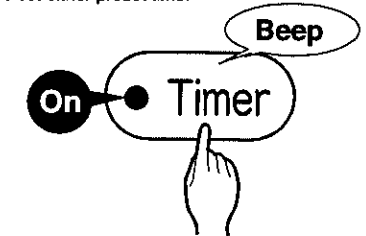

顯示窗的「Timer」閃爍，現在時間改變爲預約時間(上一次設定的時間)。
 ※每按一次「Timer」鍵，「TIMER 1」或「TIMER 2」閃爍，進行選擇。

用定時器的煮飯方法

- 預約煮好飯的時間。
- 已設定的預約時間可保持不變予以記憶。
- 記憶 2 個預約時間，「TIMER 1」和「TIMER 2」。

下述情況時不能使用定時器煮飯。
 ●下表時間以內時

食譜	不能設定定時器的時間
白米	不足1小時5分鐘
免洗米	不足1小時5分鐘
粥	不足1小時10分鐘
糙米	不足1小時30分鐘
發芽糙米	不足1小時5分鐘

- 「快煮」「什錦飯」時。
- 顯示窗的時鐘呈「0:00」閃爍時。
- 保溫燈亮燈時，按「Cancel」鍵關燈。(亮燈狀態時，無法進行預約。)

((聲音))

- 按「Timer」鍵後，約30秒鐘未做任何操作時，將發出「劈劈劈」的聲音進行提示。
- 設置爲無法煮飯的狀態時，按「Timer」或「Start」鍵，則用「劈劈劈」的聲音進行提示。

Press the [Hour] and [Min] keys to set the time to finish cooking.

3 按「Hour」「Min」鍵，設定「煮熟時間」。

- Set hours with the [Hour] key. Set minutes with the [Min] key.
- Holding down the Hour or Min key changes hours or minutes quickly.
- You may set time in 10-minute intervals.

※The previously preset time is displayed. If you want to finish timer-controlled cooking at the same preset time, you need not change the preset time.

Do not set the preset time over 12 hours. Preset times that are too long may result in spoiled rice.

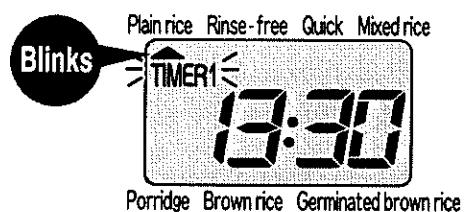

- 按「Hour」鍵，設定「小時」，按「Min」鍵，設定「分鐘」。
- 持續按壓時快速變換。
- 時間以10分鐘為單位變換。

※將會顯示上一次設定的預約時間，如果不改變預約時間則不必重新設定。

為防止米飯變質，預約時間請設在12小時之內。

Press the [Menu] key and select an intended menu.

4 按「Menu」鍵，進行選擇。

Every press of the [Menu] key moves the triangle indicator in the display unit in order. When you select a menu, the triangle indicator blinks at that menu position.

※When an intended menu has already been selected, you need not select it again.

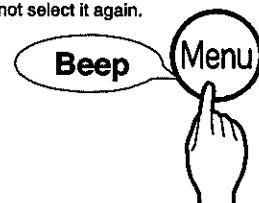

按「Menu」鍵後，顯示窗的▲逐次移動，在所選擇的食譜處停止時，▲開始閃爍。

※預先已經選定食譜時，不必再選擇食譜。

- If you do not touch any keys after pressing the [Timer] key, the rice cooker generates a "beep-beep" alarm.
- If you press the Timer or Start key in the condition where the timer is set to a value inadequate to timer-controlled cooking, the rice cooker generates a "beep-beep".

- 按下「Timer」鍵後，30秒鐘之內不操作時，發出「嗶嗶」的蜂鳴音。
- 當將定時器設在不能進行定時炊煮的位置時，按「Timer」鍵或按「Start」鍵時，將發出「嗶嗶」的蜂鳴音。

Press the [Start] key.

5 按「Start」鍵。

The triangle indicator in the display unit stops blinking and the Timer lamp turns on.

※When you fail to set the timer, press the [Cancel] key and retry setting from step 2 on the previous page.

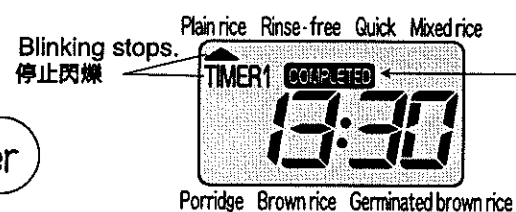
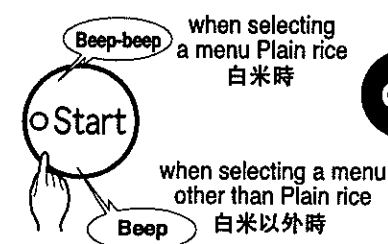

「COMPLETED」is displayed 表示「結束」

KEEPING RICE WARM

4 保溫

● Keep the taste and gloss of plain rice (and Rinse-free rice).

- 保持白米（免洗米）的美味可口性。

Keeping Rice Warm

When cooking is completed, the rice cooker begins to keep cooked rice warm automatically. It does not keep Porridge warm. The Keep warm lamp blinks while keeping the rice warm.

保溫

飯煮熟後自動切換為保溫。保溫時，保溫燈點亮。

How to stop warm keeping 中止時

- Press the [Cancel] key to stop warm keeping. The Keep Warm lamp is off.

- 要中止保溫時，按「Cancel」鍵。（保溫燈熄滅。）

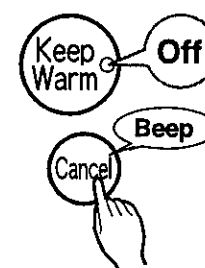

How to restart warm keeping 再次保溫時

- Press the [Keep Warm] key to restart warm keeping. The Keep Warm lamp is on.

- 再次保溫時，按「Keep Warm」鍵。（保溫燈點亮。）

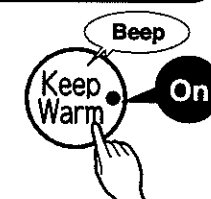

How to Keep Small Quantity of Rice Warm

Gather rice in the center of the inner pan when keeping small quantity of rice warm. Eat it as quickly as possible.

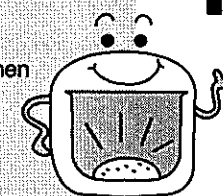

少量剩飯保溫時

保溫時請將米飯集中在鍋的中央部，最好早食用。

Display of Time Elapsed When Keeping Rice Warm

Hold the [Hour] key when keeping rice warm to display the time elapsed.

The warming time can be set from 1 hour (1 h) to 12 hours (12 h). If you keep pressing after 12 hours, the 「12」 blinks as notification.

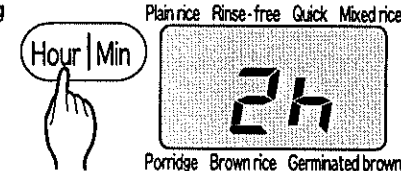

保溫過程中按「Hour」鍵時，顯示保溫的經過時間。關於保溫經過時間，按1小時為單位可表示從1小時（1h）到12小時（12h）的時間。※如果超過12小時，「12」就會通過閃爍進行通知。

保溫經過時間的顯示

● Avoid the following, which may cause an unusual odors, dryness, discoloration, and decomposition of rice and corrosion of the inner pot.

- Warming cold rice
- Adding cold rice to rice that is warming
- Placing a Spatula in the inner pan while warming
- Warming when the power cord is unplugged
- Warming for more than 12 hours
- Warming the minimum amount of rice or less. (See the specifications on P. 30)
- Warming types of rice other than plain rice and rinse-free rice

● Always remove the rice on the lid or Rubber gasket of the inner lid. It may cause dryness, discoloration, odors, and sticking.

● If the environment is harsh (cold climate or high ambient temperature), eat the rice at your earliest convenience.

● 為避免造成異味發生、發乾、變色、腐蝕及內鍋腐蝕等的原因，因此請勿進行如下保溫。

- 涼飯的保溫
- 涼飯的補充
- 放入飯勺的保溫
- 拔下萬能插口的保溫
- 12小時以上的保溫
- 最小煮飯量以下的保溫（參照P30的規格表）
- 白米、免洗米以外的保溫

● 為避免造成乾燥、變色、異味、發黏的發生，當內鍋的殘渣、密封圈中附著有飯粒等時，請務必清除。

● 使用環境過于惡劣時（寒冷地及周圍溫度高等的情況時），請儘快食用。

CLEANING AND MAINTENANCE

5

保養方法

- Clean the cooker the same day it is used for cooking to maintain cleanliness. Thoroughly clean the cooker regularly.

- 使用之後，為了長期清潔地使用，請務必在當天收拾乾淨。另外，請定期進行收拾清理。

CAUTION / 注意

Unplug the AC power cord from the power outlet, disconnect the plug to the cooker, and wait until the rice cooker cools down before starting cleaning.
先拔下電源插頭，再取下器具用插頭，待電飯鍋冷卻後再保養。

CAUTION: Any other servicing should be performed by an authorized service representative.

注意：有關其他修、售後服務，請務必委託本公司指定的保修人員。

- Do not remove the Rubber gasket.
- Always keep the Inner pan, the Lid, and the Inner lid clean to prevent corrosion and odors.
- Use kitchen detergent (for tableware and kitchen utensils) only. Do not use thinner, cleanser, bleach, disposable cloth, wire wool, or plastic kitchen sponges.
- Do not put tableware into the Inner pan to wash them together. It may cause damage or peeling of the fluorocarbon resin on the surface.
- Do not soak the lid in a detergent solution.
- Do not soak the lid or the spatula in boiling water, as it may lead to deformation.
- Do not use a dishwasher or a dryer. It may cause deformation.
- Remove the components and then wash them.
- After cooking millet (i.e. amaranthus) together with rice, please ensure that you clean the inner lid each time. If the inner lid is left unclean, the steam vent may become clogged, leading to possible breakage and a degraded cooking performance.

- 請勿取下密封圈類部件。
- 為了防止腐蝕及異味，請始終保持內鍋、蓋子以及內蓋清潔。
- 請勿使用廚房用合成洗滌劑（餐具用、烹調器用）之外的洗滌劑（稀薄劑、清潔劑、漂白劑、化學抹布、金屬刷帚、尼龍刷帚等）。
- 為避免造成氟樹脂加工面的損傷或剝離，請勿將餐具類等放入內鍋一併清洗。
- 請勿在附帶蓋子的情況下清洗。
- 為避免發生變形，因此請勿將蓋子、勺子放入熱水中。
- 為避免變形請勿使用餐具洗淨機及餐具乾燥機等。
- 請務必在取下各部之後，進行收拾清理。
- 加入雜糧（粟米等）進行煮飯後，請務必清洗內蓋。否則，可能出現內蓋的蒸氣孔堵塞、蓋子無法打開等故障，從而無法正常煮飯。

Cleaning procedure	Components / 各部件	收拾的方法
<ol style="list-style-type: none"> ① Wash with water or lukewarm water using a soft sponge. ② Wipe water with a dry cloth and dry the components completely. 		<ol style="list-style-type: none"> ① 請用水或溫水，並使用柔軟的海綿清洗。 ② 請用乾布擦拭水分，並使之充分乾燥。
<ul style="list-style-type: none"> ● Wipe the outer and inner surfaces and the power cord with a damp cloth. ● Remove burnt rice on the heater or the center sensor, if any. ● Prevent water from entering the mechanism inside the body. ● Do not allow the power cord to get wet. It may cause short-circuiting, electric shock, or failure. 		<ul style="list-style-type: none"> ● 用淨乾的布擦拭主機的外側、內側、電源軟線的污垢。 ● 燒焦的飯粒、米粒等附着於熱板及中央感應器時，請清除。 ● 請勿使水進入主機內部。 ● 請勿使電源軟線附着水或向電源軟線灑水。有可能引起短路、觸電、故障。

How to Deodorize (When rice cooker smells)

- ① Pour hot water into the inner pan up to seven-tenths or eight-tenths. Keep it warm for a couple of hours in the normal warming mode.
- ② Wash the Inner pan, the inner lid, lid, and steam cap with kitchen detergent, and then fully rinse with water.
- ③ Dry the rice cooker body and all other parts in a well-ventilated place.

消除異味的方法 (電飯鍋有異味時)

- ① 向內鍋內注入熱水至 7~8 成左右，使用普通保溫放置 2~3 小時。
- ② 請使用廚房用合成洗滌劑洗滌內鍋、內蓋、蓋子、蒸氣噴嘴之後，進行充分的清洗。
- ③ 將電飯鍋主體、各部件放置在良好的通風處，使其乾燥。

Removing and attaching the Inner lid

內蓋的取下、安裝

Pull to remove the Inner lid.
※ Push against the lid to attach it.

Please Note
Please NEVER detach the rubber seal from the lid, as it cannot be reattached.

拉到跟前取下。
※關於安裝，與取下步驟相反。

請注意
請勿拉扯上蓋的橡皮墊圈。若脫落，則無法重新安裝。

Cleaning the heater plate

Hot water may drip from the Lid while cooking and stain the surface of the Heater plate. It does not affect performance. However, if you are concerned, wipe it as shown below.

① Use a plastic kitchen sponge and a small amount of cream cleanser and scrub away the stain on the surface.

② Use wet kitchen paper towels or cloth and wipe the stain off.

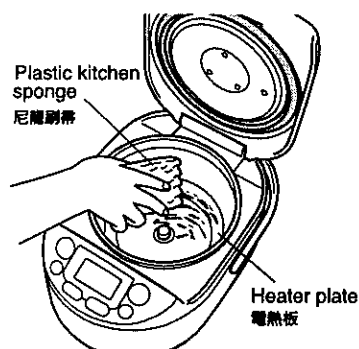

熱板污垢的去除方法

使用過程中，有時會從蓋子等掉落水滴，在電熱板中形成像污點一樣的污垢。雖然性能上沒有障礙，但感覺不妥時，請按如下方法進行收拾清理。

① 在尼龍刷帶中滴上少許市售的清潔膏，並研磨熱板污點部位。

② 用濕的廚房用紙或抹布擦拭污點。

SETTING CURRENT TIME

6

現在時間的調對方法

● Time is displayed in 24-hour format.

※ You cannot set time during cooking, keeping the rice warm or timer-controlled cooking.

● 時間以24小時製表示。

※ 煮飯、保溫、定時煮飯過程中，不能調對時間。

Insert one plug into the cooker and the other plug into the power outlet.

1

將器具用插頭插入主機，將插入式插頭插入萬能插口。

Hold the [Hour] or [Min] key for about a second to enter the time setting mode.

2

持續按「Hour」或「Min」鍵約1秒鐘，設定時間。

⌚ is displayed.

※ The clock mark disappears and time setting is disabled if you do not touch any keys in about 5 seconds after pressing the [Hour] or [Min] key.

顯示 ⌚。

※ 按「Hour」或「Min」鍵後，5秒之內不操作時，⌚ 消失，則不能調對時間。

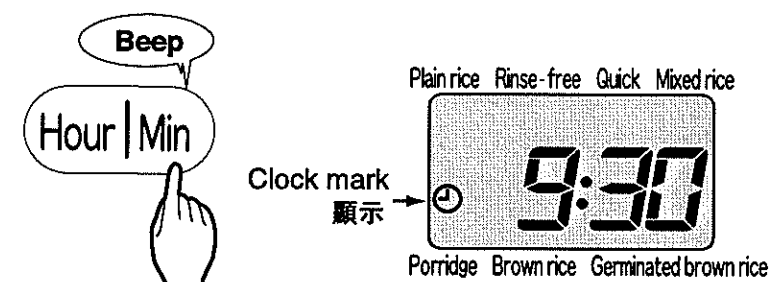

Set the time with the [Hour] and [Min] key.

3

按「Hour」或「Min」鍵，調對時間。

- Set hours with the [Hour] key. Set minutes with the [Min] key.
- Holding the [Hour] or [Min] key changes hours or minutes quickly.
- Press the "Menu" key (The clock is set.)

- 調對「小時」按「Hour」鍵，調對「分鐘」按「Min」鍵。
- 持續按鍵，快速跳躍顯示。
- 按「Menu」鍵（時間設定結束）

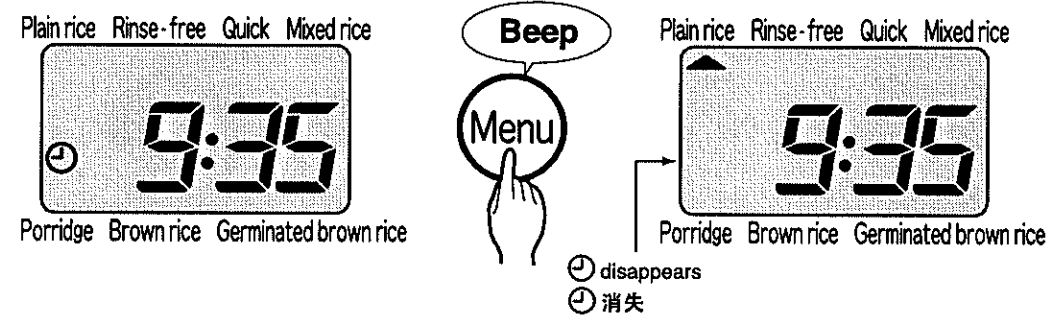

IF YOU CANNOT COOK RICE PROPERLY

7

不能煮好飯時

Check the following if you find some abnormalities in rice cooked, being cooked, or kept warm.

Check point	Quantity of rice, ingredients or water is not correct.	Wrong menu is selected.	Scorch, rice grains or water drops are on inside of inner pan, heater plate or center sensor.	Inner pan or inner lid is deformed.	The plug to the cooker was disconnected or the power supply was cut off for several hours.	Rice wasn't stirred and loosed properly.
Refer to	12·14·30	16·19	15·22·23	—	29	17
Symptom						
Cooked rice	Too hard	●	●	●	●	●
	Too soft	●	●	●	●	●
	Not cooked completely	●	●	●	●	●
	Hard center	●	●	●	●	●
	Scorched	●	●	●	●	●
During cooking	Smells like rice bran	●	●	●	●	●
	Steam leaks	●	●	●	●	●
	Boils over	●	●	●	●	●
Cooking time is too long	●	●	●	●	●	●

Check point	Scorch or rice grains are on the Rubber gasket or inner pan brim.	Rice wasn't washed thoroughly (excluding Rinse-free rice).	Hot water (over 95°F part) was used to wash rice or adjust water level.	Rice was immersed in water for a long time after washing.	The Lid is not closed tightly.	Maintenance is insufficient.
Refer to	15·22·23	12·14	14	—	15	21·22·23
Symptom						
Cooked rice	Too hard	●	●	●	●	●
	Too soft	●	●	●	●	●
	Not cooked completely	●	●	●	●	●
	Hard center	●	●	●	●	●
	Scorched	●	●	●	●	●
During cooking	Smells like rice bran	●	●	●	●	●
	Steam leaks	●	●	●	●	●
	Boils over	●	●	●	●	●
Cooking time is too long	●	●	●	●	●	●

Check point	Quantity of rice, ingredients or water is not correct.	Scorch, rice grains or water drops are on inside of inner pan, heater plate or center sensor.	The plug to the cooker was disconnected or the power supply was cut off for several hours.	Rice wasn't stirred and loosed properly.	Scorch or rice grains are on Rubber gasket or inner pan brim.	Rice wasn't washed thoroughly (excluding Rinse-free rice).
Refer to	12·14·30	15·22·23	29	17	15·22·23	12·14
Symptom						
Warm-kept rice	Smells	●	●	●	●	●
	Discolored	●	●	●	●	●
	Dry	●	●	●	●	●

Check point	Preset time exceeds 12 hours.	Rice has been kept warm for 12 hours.	Rice other than Plain rice and Rinse-free rice was kept warm.	Rice less than lower limit is kept warm.	Cold rice was added.	Rice is kept warm with Spetula inside.
Refer to	18·19	20	20	20·30	20	20
Symptom						
Warm-kept rice	Smells	●	●	●	●	●
	Discolored	●	●	●	●	●
	Dry	●	●	●	●	●

Check point	Insufficient care.	
Refer to	21·22·23	
Symptom		
Warm-kept rice	Smells	●
	Discolored	●
	Dry	●

煮過的米飯、炊煮或保溫過程中的米飯出現異常時，請檢查以下事項。

檢查事項	米量及菜骨量、加水量不正確	食譜的選擇錯誤	內鍋蓋、電熱板、中央傳感器上粘有飯渣、米粒和水滴等	內鍋或內蓋變形	器具用細眼篩網或長時間停電	煮熟後的米飯翻動得不均勻
參照頁次	13·14·30	16·19	15·22·23	—	29	17
下述情況時						
煮好的米飯	過硬	●	●	●	●	●
	過軟	●	●	●	●	●
	夾生	●	●	●	●	●
	有硬米芯	●	●	●	●	●
	出現鍋巴	●	●	●	●	●
炊煮過程中	有米糠味	●	●	●	●	●
	蒸氣漏泄	●	●	●	●	●
	溢出	●	●	●	●	●
炊煮時間長	●	●	●	●	●	●

檢查事項	密封圈、內鍋邊緣上等處粘有飯渣和米粒	大米淘洗得不乾淨 (不包括免洗米)	用熱水 (超過35°C) 淘米或加入熱水	淘米後長時間用水浸泡	鍋蓋蓋得不嚴	未清洗乾淨
參照頁次	15·22·23	13·14	14	—	15	21·22·23
下述情況時						
煮好的米飯	過硬	●	●	●	●	●
	過軟	●	●	●	●	●
	夾生	●	●	●	●	●
	有硬米芯	●	●	●	●	●
	出現鍋巴	●	●	●	●	●
炊煮過程中	有米糠味	●	●	●	●	●
	蒸氣漏泄	●	●	●	●	●
	溢出	●	●	●	●	●
炊煮時間長	●	●	●	●	●	●



檢查事項	米量及菜骨量、加水量不正確	內鍋蓋、電熱板、中央傳感器上粘有飯渣、米粒和水滴等	器具用細眼篩網或長時間停電	煮熟後的米飯翻動得不均勻	密封圈、內鍋邊緣上等處粘有飯渣和米粒	大米淘洗得不乾淨 (不包括免洗米)
參照頁次	13·14·30	15·22·23	29	17	15·22·23	13·14
下述情況時						
保溫過程中的米飯	有味兒	●	●	●	●	●
	變色	●	●	●	●	●
	乾硬	●	●	●	●	●

檢查事項	定時預約定超過12小時	持續保溫超過12小時	保溫白米、免洗米以外的食品	保溫的飯量少於最小限度	添加涼飯	飯勺放在鍋內保溫
參照頁次	18·19	20	20	20·30	20	20
下述情況時						
保溫過程中的米飯	有味兒	●	●	●	●	●
	變色	●	●	●	●	●
	乾硬	●	●	●	●	●

檢查事項	保養不佳時	
參照頁次	21·22·23	
下述情況時		
保溫過程中的米飯	有味兒	●
	變色	●
	乾硬	●

Check the following before requesting repair service. Contact the dealer where you purchased the product if the problem is not solved even though you have performed the actions.

About molded-resin components
 ※The components subject to heat and steam may deteriorate with time.
 In such a case, please contact the store where you purchased the product.

 CAUTION Never attempt to repair the rice cooker by yourself. Unauthorized repair may lead to a dangerous accident.			
Symptom	Check point	Action	Refer to
Rice is not cooked.	Is the plug inserted into the cooker?	Insert the plug into the cooker.	15·29
Rice hasn't been cooked by preset time.	Is the current time set correctly?	Set the current time correctly.	24
	Is the plug inserted into the cooker?	Insert the plug into the cooker.	15·29
Impossible to set the timer.	See "Cooking time is too long" on page 25 and take the proper measures.		
	Is the current time set correctly?	Set the current time correctly.	24
	Does "0:00" blink?	The lithium battery is dead. Contact the dealer where you purchased the product.	10
	Is either the [Quick] or the [Mixed rice] setting selected?	Timer-controlled cooking for the [Quick] and [Mixed rice] setting is not available.	18
Display unit blurs.	Did you set an inapplicable time?	Set time suitable to timer-controlled cooking.	18·19
	Are scorch and rice grains stuck on the Rubber gasket or brim of the Inner pan?	Remove them entirely.	15·22·23
Noise issued from the rice cooker during the cooking, steaming or warming of rice.	Is the outer surface of the Inner pan wet?	Wipe the wet surface with dry cloth.	15·22·23
	Water splashing sound (Only when cooking or steaming rice)	This is not a defect.	11
	"Click-click" sound	Microcomputer's sound. This is not a defect.	11
A "beep-beep-beep" alarm is generated when presetting time for timer cooking.	"Splash" sound (Only when keeping rice warm)	It is generated by the metallic parts, which contract due to heat. It is not a defect.	11
	A noise quite different from the above is heard.	Contact the dealer where you purchased the product.	—
Pressing the [Hour] or [Min] key does not establish the time setting mode.	It is generated if you do not touch any keys in 30 seconds after pressing the [Timer] key.	Set time immediately after pressing the [Timer] key.	18·19
Water or rice has entered the rice cooker body.	You cannot adjust time while cooking, warming, or when the timer is set.		24
The Keep warm lamp blinks.	Water or rice may cause trouble. Contact the dealer where you purchased the product.		—
Keep warm time elapsed blinks.	Is the "Porridge" menu selected?	Porridge should not be kept warmed long, as it will cook further and become like glue. We recommend you to eat it at your earliest convenience.	17
The stored current time, preset time and warm keeping time elapsed are lost when the AC cord is unplugged.	Have you kept the rice warmed for more than 12 hours?	When the rice is warmed for more than 12 hours, the "12" and "Warming time elapsed" displays blink.	20
	Does "0:00" blink when plugging the AC cord?	The lithium battery is dead. Contact the dealer where you purchased the product.	10
Continuous "tweet" or "beep-beep-beep" is heard.	Is "Err" displayed in the display unit? 	The rice cooker is faulty. Unplug the AC cord, and contact the dealer where you purchased the product.	—
Pressing a key causes no reaction of the rice cooker.	Is one end of the plug inserted into the cooker and the other into the power outlet?	Make sure that one end of the plug is inserted into the cooker and the other plug into the power outlet.	5·15
	Is "Err" displayed in the display unit? 	The rice cooker is faulty. Unplug the AC cord, and contact the dealer where you purchased the product.	—
	Is the Keep Warm lamp on?	Press the [Cancel] key to cancel warm keeping. Then, retry operation.	15
Smells of resin.	Do you begin to use the rice cooker first?	Such smell will vanish as you use the rice cooker.	—
Plastic parts have stripes or waves.		Such stripes and waves are produced when forming resin. They cause no harm in practical use.	—

在委託修理之前，請檢點以下事項。
 檢點處理後如不能復原，請惠詢經銷店。

關於樹脂成型品
 ※接觸熱氣及蒸氣的成型品在使用的過程中，有時會出現損傷的情況。請諮詢購買的銷售店。

 注意 禁止自行修理以免發生危險。檢點處理後如不能復原，請惠詢經銷店。			
出現以下情況時	檢查此處	照此處理	參照頁次
無法煮飯	器具用插頭是否出現了脫落。	請插入器具用插頭。	15·29
不能按設定的時間煮熟飯	現在時間的設定是否正確。	請正確設定時間。	24
	器具用插頭是否出現了脫落。	請插入器具用插頭。	15·29
不能設定定時器	確認第26頁中「炊煮時間過長」一項後，作適當處理。		
	目前的時間是否正確。	請正確調整時間。	24
	顯示時間「0:00」不閃爍。	經電池耗盡，請惠詢經銷店。	10
	是否選擇了「快煮」「燒煮」的菜單。	不能進行「快煮」「燒煮」的定時煮飯。	18
顯示窗模糊不清	是否選擇不能使用定時器的時間了。	請再可設定定時器的時間內進行定時炊煮。	18·19
	密封圈或內鍋邊緣是否粘有飯渣和米粒。	請清除乾淨。	15·22·23
煮飯、蒸煮、保溫過程中發出聲音	內鍋的外側是否有水。	用乾抹布擦乾。	15·22·23
	煮飯過程中水沸騰的聲音。(僅限於炊煮、蒸煮過程中)	不是故障。	11
	「劈劈劈」聲。	微型計算機的控制音。不是故障。	11
	「滴嗒滴嗒」聲。(僅限於保溫過程中)	金屬受熱收縮時發出的摩擦聲音。不是故障。	11
發出與上述截然不同的聲音。	請惠詢經銷店。	—	
預約定時炊煮時發出「噹噹」的聲音	按「Timer」鍵後，30秒之內不操作時將發出「噹噹」的聲音。	請繼續設定定時器。	18·19
調整時間時，即使按「Hour」或「Min」鍵也不能進入時間設定模式	煮飯、保溫、定時預約時，不能進行時間調整。		24
電飯鍋主體內浸水或滲入米粒	會導致故障，請惠詢經銷店。		—
保溫燈閃爍	是否選擇了「粥」的菜單。	關於「粥」如果放置不管，就會成為糊狀或發黏，因此請儘快食用。	17
保溫經過時間閃爍	是否進行了12小時以上的保溫。	如果保溫時間超過12小時，「12」和「保溫時間」就會通過閃爍進行通知。請將保溫時間設置在12小時以內。	20
按下電源插頭後，現在時間和預約時間以及保溫經過時間的記憶消失	插入電源插頭後，顯示窗上「0:00」是否閃爍。	經電池耗盡，請惠詢經銷店。	10
「嗶——」持續鳴響或發出「噹噹噹噹……」的聲音	表示部中是否顯示有「Err」。 	電飯鍋主體異常。按下電源插頭，請惠詢經銷店。	—
按鍵失靈	器具用插頭是否插入了主機，插入式插頭是否插入了萬能插口。	請切實將器具用插頭插入主機，將插入式插頭插入萬能插口。	5·15
	顯示窗上是否顯示「Err」。 	電飯鍋主體異常。按下電源插頭，請惠詢經銷店。	—
	保溫燈是否點亮。	按「Cancel」鍵，取消保溫後再重新操作。	15
有樹脂等的味道	是否是剛開始使用。	伴隨使用將會逐漸消失。	—
塑料部分出現綫狀或波狀的條紋	這是樹脂成形時出現的綫狀和波狀條紋痕跡。不是質量問題，不影響使用。		—

When the plug to the cooker is disconnected or the power supply is cut off

If the plug is disconnected from the cooker while cooking, warming, or when the time is set, insert it again immediately. Then the operation will continue. If the power supply is cut off, the operation will continue properly when the power is turned back on.

If the plug to the cooker is disconnected or the power supply is cut off during the following operation,	What happens when the power is supplied again
When setting the timer	The timer works without troubles. (If a power failure lasts long and the preset time has passed, the rice cooker begins to cook rice immediately.)
Cooking	The cooker continues cooking.
Warming	The cooker continues warming.

Under certain conditions, the rice may not be cooked correctly or the rice-warming temperature may become lowered.

器具用插頭脫落及停電時

如果在煮飯、保溫、定時預約時出現器具用插頭脫落的情況，請立即插入。繼續進行斷電前的操作。即使萬一停電，只要重新接通電源，功能就會恢復正常。

此時出現器具用插頭脫落或停電時	再次通電後
設定時器時	定時器照常運轉。 (停電時間過長，超過所設定的時間時，通電後立即開始炊煮。)
煮飯時	繼續煮飯。
保溫時	繼續保溫。

※根據條件的不同，可能無法正常煮飯，或使保溫的溫度降低。

SPECIFICATIONS 規格

Size		0.54L type	
Power source		AC:120V	
Power consumption	Cooking	487W	
	Warming (average power consumption)	18W	
Cooking capacity (liters)	Plain rice	0.09~0.54	
	Rinse-free rice	0.09~0.54	
	Quick	0.09~0.54	
	Mixed rice	0.09~0.36	
	porridge	Soft porridge	0.045~0.13
		Hard porridge	0.045~0.09
	Brown rice	0.09~0.36	
	Germinated brown rice	0.09~0.54	
	Outside dimensions (Approximate values in inches)	Width	8.7
Depth		12.2	
Height		7.0	
Weight (Approximate values in pound)		5.7	

● The power consumption during warming indicates the average consumption at rated voltage, at a room temperature of 68°F (20°C), and when the volume of rice is at the maximum.

● The clock may have a margin of error of 30-120 seconds/month, depending on room temperature and/or usage manner.

尺寸		0.54L type	
電源		AC:120V	
耗電量	炊煮時	487W	
	平均保溫時	18W	
煮飯容量 (公升)	白米	0.09~0.54	
	免洗米	0.09~0.54	
	快煮	0.09~0.54	
	什錦飯	0.09~0.36	
	粥	全粥	0.045~0.13
		五分粥	0.045~0.09
	糙米	0.09~0.36	
	發芽糙米	0.09~0.54	
外形尺寸 (約厘米)	寬	22.0	
	長	30.8	
	高	17.7	
電飯鍋質量 (約公斤)		2.6	

● 保溫時的耗電量是、額定電壓、室溫20°C滿量保溫時的平均電力 (約)。

● 根據室內溫度或使用方法的不同，時鐘在1個月內，可能產生30至120秒的偏差。

STANDARD COOKING TIME

Plain rice	40~55 minutes
Rinse-free rice	42~55 minutes
Quick	19~40 minutes
Mixed rice	41~51 minutes
Porridge	60~70 minutes
Brown rice	69~79 minutes
Germinated brown rice	41~58 minutes

※ The above indicates the time from pressing the [Start] button to the end of steaming after cooking (at rated voltage, at a room/water temperature of 68°F (20°C), at standard water level).

※ The cooking time varies according to the volume and type of rice, volume and type of the vegetables/meat, room/water temperature, volume of water, voltage, and whether the time is used or not.

煮飯所需時間

白米	40~55 分鐘
免洗米	42~55 分鐘
快煮	19~40 分鐘
什錦飯	41~51 分鐘
粥	60~70 分鐘
糙米	69~79 分鐘
發芽糙米	41~58 分鐘

※ 上述時間為快速煮熟到爛好的時間。(額定電壓、室溫20°C、水溫20°C、加減水量為標準水位)

※ 煮飯時間根據米量、大米的種類、切碎的蔬菜、魚、肉等的種類及量、室溫、水溫、加減水量、電壓、定時等情況多少有些差異。